

THE WEJTAP™ SYSTEM

FOR ELECTRIC UTILITY
DISTRIBUTION AND
TRANSMISSION
CONNECTIONS



J-1

Blue highlighted items are industry standard and most frequently ordered.

TABLE OF CONTENTS

WEJTAP™ Connection System	J-3	WEJTAP™ Installation Tools WTB, WTHRB1S, WTBGBW, WTHY1S	J-10
WEJTAP™ and Test Data	J-4	Installation Tool Accessories WTOCBR, WTOCY, WTCK, WTBASY1	J-10
WEJTAP™ Ordering Information	J-5	WEJTAP™ Power Lug	J-11
WEJTAP™ Cover WCCR, WCCB, WCCSY, WCCLY	J-5	WEJTAP™ Hotstick Accessories WHSCWH, WHSPBC, WHSSADP, WHSWADP, WCHAWAS, WHSTA, WHSWB, WHSGB, WHHWB	J-12
WEJTAP™ Connector Selection Chart By Diameter	J-6 - J-8	WEJTAP™ Kit Ordering Instructions	J-13
WEJTAP™ STIRRUP™ and Power Boosters	J-9	 WEJTAP™ In-Line Disconnect	J-14
WEJTAP™ STIRRUP™ Selection Chart	J-9		



Blue highlighted items are industry standard and most frequently ordered.

BURNDY WEJTAP™

CONNECTION SYSTEM

BURNDY®, a leading manufacturer of quality electrical connectors for over 70 years, introduces the WEJTAP™ SYSTEM, a system that adds further dimension to the existing BURNDY® group of proven, reliable connection systems.

WEJTAP™ COMPONENTS are designed to provide a reliable system connection. The system consists of WEJTAP™ connectors, installation tools (including a variety of hot-line and lineman accessories) and a unique power-booster.

WEJTAP™ CONNECTORS use an aluminum alloy wedge that is power-driven between the run and the tap cables locking them into a “C” shaped tempered aluminum alloy spring-body. The spring-body maintains consistent pressure throughout the life of the connection to ensure reliability during severe electrical and climatic conditions. The wedge’s wiping action combined with factory installed PENTX 1530 provides superior contact integrity. The wedge is automatically locked onto the spring-body by a skiving action produced by a lance at the forward end of the WEJTAP™ installation tool.

THE WEJTAP™ TOOL is a one-piece assembly that consists of a head and power unit. Two color-coded interchangeable heads accept all WEJTAP™ connectors and STIR-RUP™. The design of the tool recognizes the need for simplicity and speed of operation as well as outstanding safety features such as automatic gas release vented away from the operator, fast simple breech loading and fast advance when engaging the connector assembly. No loose parts to drop or misplace and a booster ejection system that provides further safety to the operator. Fewer simplified hotline devices and handy lineman accessories complete an outstanding tool package.

THE WEJTAP™ POWER-BOOSTER Patented is a self-contained device that provides the force necessary to drive the wedge into direct contact with the conductors. The booster is activated only when properly positioned in the tool assembly. A power cell in the booster is recessed to guard against premature discharge. The tool/booster system is designed to activate and deactivate the booster automatically should the operator decide to remove the tool from a connector prior to completing the installation. The deactivated booster may be safely removed from the tool.

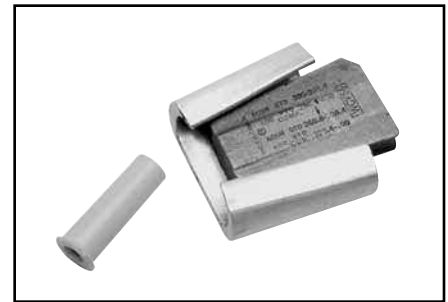

Features and Benefits

- Large conductor chamfer on ends of wedge.
 - ◊ Instant hand or visual identification of large run grooves. Ensures correct wedge orientation.
- Color-coded WEJTAP™ connector and booster packaged together.
 - ◊ Easy selection by installer.
- Factory coated grooves with PENTX 1530.
 - ◊ Maintains low contact resistance, assists in protection against climatic conditions and is compatible with common insulations.
- One-piece tool.
 - ◊ No project delays due to dropped or lost parts.
- Fewer and improved hotstick accessories
 - ◊ Simplifies hotline installation and saves time.
- Contained booster ejection system.
 - ◊ Safe for operator guards against the booster being ejected in direction of the installer.
- Automatic gas release vented away from operator.
 - ◊ Eliminates manual gas venting and improves safety.
- Simplified loading.
 - ◊ Speeds installation—no threads—just depress safety bar, twist and pull open—load—push and twist to close prior to applying connector.
- Acme-type threads.
 - ◊ Provides smooth, fast engagement of tool and connector-saves installer’s time.

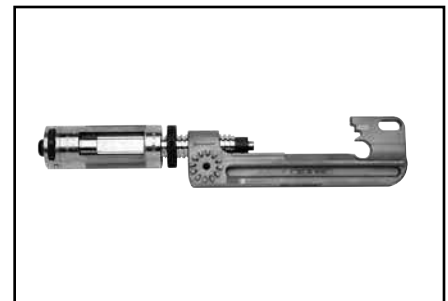

Blue highlighted items are industry standard and most frequently ordered.

WEJTAP™ AND TEST DATA

WEJTAP™ connectors have been subjected to extensive tests simulating the most severe service and weather conditions. In addition, the WEJTAP™ system meets or exceeds the industry standards of ANSI C119.4 Class 3, NEMA CC3 1973 Class AA, 500 Heat Cycles.

As with all BURNDY® connectors, the WEJTAP™ has been designed to operate cooler than the attached conductors. The WEJTAP™ connectors have also been subjected to the ASTM B117-73 Salt Spray Test. The results are shown to the right.

ANSI C119.4 - 1986 Heat Cycle Test
Average Temperature Rise vs. Current Cycles

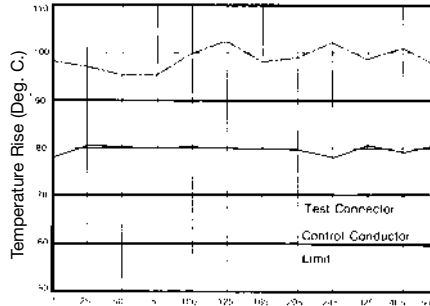

Detailed test report packages are available upon request.

ASTM Salt Spray Test
Average % Relative Resistance vs. Hours of Salt Spray Exposure

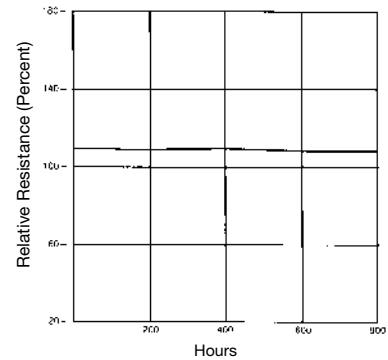

WEJTAP™

C-member bodies are color-coded and the wedges are marked with nominal conductor run and tap ranges. WEJTAP™ connector packages are labeled with a variety of common conductors with their nominal ranges.

J-4

- WEJTAP™ connector wedges are marked with nominal ACSR, Aluminum and Copper concentric standard conductors.
- Red WEJTAP™ connector range Run 8-1/0 Tap 8-2
- Blue WEJTAP™ connector range Run 2-300 Tap 6-300
- Yellow WEJTAP™ connector range Run 266.8-1590 Tap 6-1590

All WEJTAP™ wedges contain a clearly defined chamfer on the large end of the run conductor groove to identify the “large run” groove. Installers will appreciate the convenience of visual or hand identification for correct wedge positioning.

WEJTAP™ wedges are driven between the run and tap conductors and activate the spring characteristics of the “C” shaped body. This action maintains contact pressure even when the connection is subjected to severe climatic and electrical conditions.



RUS Accepted

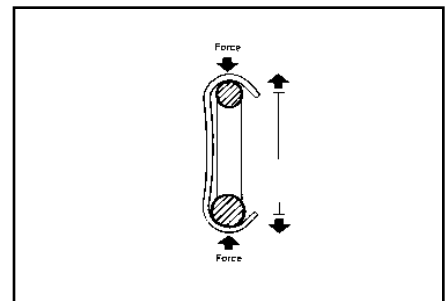
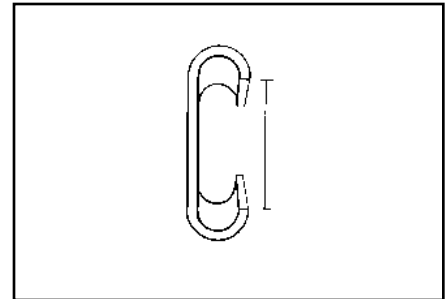

Blue highlighted items are industry standard and most frequently ordered.

The BURNDY® WEJTAP™ System has a wide variety of connectors available for many different conductor ranges.

Color coded boosters and connectors ensure proper matching during installation.

The BURNDY® Power Booster is designed and engineered for the highest reliability and safety. Proven rimfire design means misfires are almost nonexistent. Close manufacturing component tolerances provide maximum resistance to moisture or submersion.

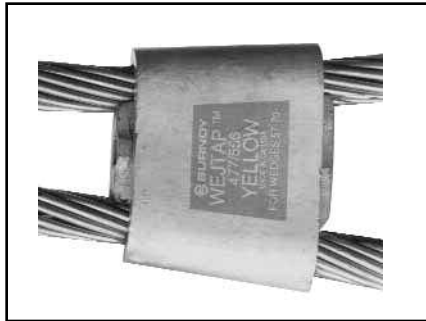

ORDERING INFORMATION

■ Power boosters may be ordered separately in boxes of 25.

- Red boosters Cat. # **WPBRN Box 25**
- Blue boosters Cat. # **WPBBN Box 25**
- Yellow boosters Cat. # **WPBYN Box 25**



Select appropriate connector from pages J-6 - J-10. Match with equal number of color coded boosters (see below).

WPB—Red, Blue, Yellow Boosters

For information about conductors which are not listed, and for further ordering information, please contact BURNDY® at 1-800-346-4175.

WEJTAP™ COVER

WEJTAP™ Covers are installed on WEJTAP™ connectors to prevent them from coming in contact with other taps or exposed ground points. The covers are rugged snap-on devices available in four sizes to cover all connector sizes.



Cover Catalog Number	WEJTAP™ Size	Nominal Conductor Range		Cover Color
		Run	Tap	
WCCR	Small Old Style Red	8 - 1/0	8 - 2	Black Weather Rated
WCCB	Red & Blue	2 - 300	6 - 300	
WCCSY	Small (Yellow)	300 - 556.5	6 - 556.5	
WCCLY	Large (Yellow)	556.5 - 1033.5	556.5 - 1033.5	

Blue highlighted items are industry standard and most frequently ordered.

BURNDY WEJTAP™ SELECTION CHART

By Diameter

Catalog Number	Sum of Diameters		Run		Tap	
	Max	Min	Max	Min	Max	Min
Installed with red booster						
WCR29	0.723	0.584	0.398	0.257	0.398	0.257
WCR30	0.649	0.516	0.398	0.257	0.325	0.206
WCR31	0.602	0.464	0.398	0.257	0.258	0.162
WCR32	0.530	0.410	0.326	0.204	0.258	0.162
WCR33	0.459	0.331	0.258	0.169	0.230	0.162
WCR34	0.324	0.256	0.162	0.128	0.162	0.128
WCR35	0.560	0.452	0.398	0.257	0.162	0.128
WCR36	0.487	0.387	0.398	0.257	0.162	0.128
WCR37	0.416	0.297	0.258	0.169	0.162	0.128
Installed with blue booster						
WCB10	0.795	0.621	0.482	0.316	0.437	0.257
WCB11	0.901	0.763	0.568	0.364	0.457	0.257
WCB12	0.707	0.526	0.568	0.364	0.204	0.162
WCB13	0.761	0.600	0.568	0.364	0.258	0.204
WCB14	0.839	0.690	0.568	0.364	0.398	0.257
WCB15	0.769	0.622	0.568	0.364	0.204	0.162
WCB16	0.823	0.664	0.568	0.364	0.258	0.204
WCB17	0.963	0.804	0.568	0.364	0.464	0.257
WCB18	1.011	0.867	0.568	0.364	0.572	0.364
WCB19	1.068	0.938	0.568	0.364	0.572	0.379
WCB20	1.130	0.975	0.568	0.364	0.572	0.386
WCB21	0.846	0.711	0.650	0.532	0.204	0.162
WCB22	0.900	0.765	0.650	0.532	0.258	0.204
WCB23	0.972	0.818	0.650	0.532	0.330	0.257
WCB24	1.052	0.897	0.650	0.532	0.500	0.324
WCB25	1.104	0.963	0.650	0.532	0.562	0.364
WCB26	1.163	1.015	0.650	0.532	0.562	0.409
WCB27	1.221	1.080	0.650	0.532	0.575	0.460
WCB28	1.284	1.141	0.650	0.532	0.650	0.525
WCB40	0.888	0.762	0.684	0.603	0.204	0.162
WCB41	0.942	0.794	0.684	0.600	0.258	0.204
WCB42	1.011	0.857	0.684	0.600	0.333	0.257
WCB43	1.094	0.936	0.684	0.600	0.500	0.324
WCB44	1.146	1.009	0.684	0.600	0.562	0.364
WCB45	1.204	1.057	0.684	0.600	0.562	0.409
WCB46	1.284	1.119	0.684	0.600	0.592	0.460
WCB47	1.368	1.188	0.684	0.600	0.684	0.600
Installed with yellow booster						
WCY48	0.932	0.765	0.750	0.537	0.204	0.162
WCY49	1.012	0.807	0.750	0.537	0.271	0.203
WCY50	1.069	0.860	0.750	0.537	0.355	0.257
WCY51	1.141	0.927	0.750	0.537	0.557	0.324

J-6

Blue highlighted items are industry standard and most frequently ordered.

**BURNDY WEJTAP™
SELECTION CHART**

By Diameter

Catalog Number	Sum Of Diameters		Run		Tap	
	Max.	Min.	Max.	Min.	Max.	Min.
Installed with yellow booster						
WCY52	1.190	1.001	0.750	0.537	0.588	0.364
WCY53	1.236	1.012	0.750	0.537	0.619	0.409
WCY54	1.302	1.063	0.750	0.537	0.630	0.46
WCY55	1.370	1.140	0.750	0.537	0.714	0.499
WCY56	1.456	1.245	0.750	0.537	0.750	0.524
WCY57	1.190	0.979	0.893	0.666	0.326	0.257
WCY58	1.087	0.931	0.893	0.666	0.258	0.198
WCY59	1.061	0.891	0.893	0.666	0.199	0.162
WCY60	1.854	1.686	0.950	0.722	0.950	0.722
WCY61	1.741	1.524	0.940	0.683	0.940	0.666
WCY62	1.594	1.379	0.940	0.683	0.750	0.573
WCY63	1.500	1.297	0.940	0.683	0.750	0.481
WCY64	1.421	1.216	0.940	0.683	0.650	0.436
WCY65	1.360	1.147	0.940	0.683	0.562	0.382
WCY66	1.305	1.097	0.940	0.683	0.562	0.336
WCY67	1.270	1.054	0.940	0.683	0.450	0.315
WCY68	1.253	1.115	0.940	0.683	0.326	0.257
WCY69	1.187	1.059	0.940	0.683	0.262	0.204
WCY70	1.130	1.013	0.940	0.683	0.204	0.162
WCY71	2.216	2.074	1.133	0.907	1.156	0.947
WCY72	2.133	1.999	1.133	0.907	1.142	0.927
WCY73	2.098	1.946	1.133	0.907	1.142	0.907
WCY74	2.035	1.891	1.133	0.907	1.142	0.858
WCY75	1.969	1.822	1.133	0.889	0.927	0.763
WCY76	1.901	1.741	1.133	0.889	0.900	0.700
WCY77	1.829	1.677	1.133	0.889	0.750	0.575
WCY78	1.750	1.599	1.133	0.889	0.729	0.525
WCY79	1.670	1.526	1.133	0.889	0.722	0.364
WCY80	1.610	1.466	1.133	0.889	0.608	0.364
WCY81	1.555	1.411	1.133	0.889	0.608	0.364
WCY82	1.506	1.362	1.133	0.889	0.436	0.324
WCY83	1.440	1.288	1.133	0.889	0.398	0.257
WCY84	1.369	1.221	1.133	0.889	0.333	0.203
WCY85	1.306	1.158	1.133	0.889	0.258	0.162
WCY86	2.496	2.332	1.250	0.893	1.250	0.999
WCY87	2.418	2.251	1.250	0.893	1.250	0.856
WCY88	2.354	2.194	1.250	0.893	1.211	0.971
WCY89	2.297	2.137	1.250	0.893	1.200	0.923
WCY90	2.238	2.083	1.250	0.893	1.159	0.868
WCY91	2.173	2.013	1.250	0.893	1.130	0.856
WCY92	2.104	1.950	1.250	0.893	0.904	0.720
WCY93	2.029	1.869	1.250	0.893	0.900	0.700
WCY94	1.967	1.831	1.250	0.893	0.750	0.588
WCY95	1.888	1.728	1.250	0.893	0.722	0.525
WCY96	1.811	1.648	1.250	0.893	0.609	0.364
WCY97	1.748	1.591	1.250	0.893	0.598	0.385
WCY98	1.695	1.533	1.250	0.893	0.598	0.364
WCY99	1.644	1.489	1.250	0.893	0.398	0.324

J-7

Blue highlighted items are industry standard and most frequently ordered.

**BURNDY WEJTAP™
SELECTION CHART**

By Diameter

Catalog Number	Sum Of Diameters		Run		Tap	
	Max.	Min.	Max.	Min.	Max.	Min.
Installed with yellow booster						
WCY100	1.572	1.400	1.250	0.893	0.351	0.257
WCY101	1.503	1.343	1.250	0.893	0.261	0.204
WCY102	1.454	1.284	1.250	0.893	0.198	0.162
WCY103	2.604	2.484	1.302	1.242	1.302	1.242
WCY104	2.567	2.407	1.302	1.242	1.265	1.165
WCY105	2.489	2.329	1.302	1.242	1.187	1.087
WCY106	2.418	2.258	1.302	1.242	1.116	1.016
WCY107	2.373	2.213	1.302	1.242	1.071	0.971
WCY108	2.318	2.158	1.302	1.242	1.016	0.916
WCY109	2.255	2.095	1.302	1.242	0.953	0.853
WCY110	2.179	2.019	1.302	1.242	0.877	0.777
WCY111	2.102	1.942	1.302	1.242	0.800	0.700
WCY112	2.044	1.884	1.302	1.242	0.742	0.642
WCY113	1.961	1.801	1.302	1.242	0.659	0.559
WCY114	1.940	1.740	1.350	1.242	0.590	0.498
WCY115	1.863	1.663	1.350	1.242	0.513	0.421
WCY116	1.812	1.612	1.350	1.242	0.462	0.370
WCY117	1.762	1.562	1.350	1.242	0.412	0.320
WCY118	1.703	1.503	1.350	1.242	0.353	0.261
WCY119	1.631	1.431	1.350	1.242	0.281	0.189
WCY120	1.580	1.380	1.350	1.242	0.230	0.138
WCY121	2.844	2.642	1.422	1.314	1.422	1.328
WCY122	2.764	2.562	1.422	1.314	1.342	1.248
WCY123	2.680	2.479	1.422	1.314	1.258	1.164
WCY124	2.596	2.394	1.422	1.314	1.174	1.080
WCY125	2.535	2.333	1.422	1.314	1.113	1.019
WCY126	2.481	2.279	1.422	1.314	1.059	0.965
WCY127	2.426	2.224	1.422	1.314	1.004	0.910
WCY128	2.376	2.174	1.422	1.314	0.954	0.860
WCY129	2.286	2.084	1.422	1.314	0.864	0.770
WCY130	2.216	2.014	1.422	1.314	0.794	0.700
WCY131	2.152	1.950	1.422	1.314	0.730	0.636
WCY132	2.070	1.868	1.422	1.314	0.648	0.554
WCY133	1.990	1.786	1.422	1.314	0.568	0.472
WCY134	1.931	1.729	1.422	1.314	0.509	0.415
WCY135	1.876	1.674	1.422	1.314	0.454	0.360
WCY136	1.831	1.629	1.422	1.314	0.409	0.315
WCY137	1.771	1.569	1.422	1.314	0.349	0.255
WCY138	1.706	1.504	1.422	1.314	0.284	0.190
WCY139	1.664	1.462	1.422	1.314	0.242	0.148
WCY140	3.045	2.090	1.533	1.471	1.547	1.471
WCY145	2.596	2.534	1.533	1.032	1.094	1.032

Blue highlighted items are industry standard and most frequently ordered.

**WEJTAP™
STIRRUP™ AND
POWER BOOSTERS**

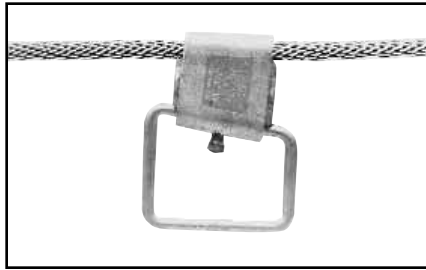

(Large) Run Conductor position is identified on all wedges via a distinct chamfer.

QIK Selector - for common ACSR, Aluminum and Copper Conductors

Catalog Number	Nominal Cable Range	Bail Size
Small Red Cable Range 6-2		
WSS1	6	2
WSS2	5, 4, 2	2
Medium Blue Cable Range 1-300		
WSM1	1, 1/0, 2/0	2
WSM2	2/0, 3/0	2
WSM3	3/0 - 4/0	2
WSM4	3/0 - 4/0	2/0
WSM5	266.8	2
WSM6	266.8	1/0
WSM7	350	1/0
WSM11	266.8 - 336.4	4/0

Catalog Number	Nominal Cable Range	Bail Size
Large Yellow Cable Range 300-1033.5		
WSL1	336.4	1/0
WSL2		2/0
WSL3		4/0
WSL4	397.5 - 477	1/0
WSL5		2/0
WSL6		4/0
WSL7	556.5	1/0
WSL8		2/0
WSL9		4/0
WSL10	636	4/0
WSL11		2/0
WSL12	795	2/0
WSL13		4/0
WSL14	1033.5	4/0

J-9

**BURNDY WEJTAP™
STIRRUP™
SELECTION CHART**

By Diameter

Catalog Number	Sum of Diameters		Run		Tap	
	Max.	Min.	Max.	Min.	Max.	Min.
Small stirrups						
WSS1	0.454	0.412	0.204	0.162	0.25	0.25
WSS2	0.575	0.456	0.325	0.206	0.25	0.25
Medium sized stirrups						
WSM1	0.697	0.575	0.447	0.325	0.25	0.25
WSM10	0.887	0.784	0.563	0.46	0.324	0.324
WSM2	0.752	0.615	0.502	0.365	0.25	0.25
WSM3	0.813	0.66	0.563	0.41	0.25	0.25
WSM4	0.938	0.835	0.563	0.46	0.375	0.375
WSM5	0.892	0.787	0.642	0.537	0.25	0.25
WSM6	0.968	0.861	0.642	0.537	0.324	0.324
WSM7	1.008	0.898	0.684	0.574	0.324	0.324
WSM8	0.934	0.824	0.684	0.574	0.25	0.25
WSM9	0.771	0.649	0.447	0.325	0.324	0.324
Large stirrups						
WSL1	1.05	0.927	0.726	0.603	0.324	0.324
WSL10	1.479	1.389	1.019	0.929	0.46	0.46
WSL11	1.394	1.304	1.019	0.929	0.375	0.375
WSL12	1.515	1.399	1.14	1.024	0.375	0.375
WSL13	1.6	1.484	1.14	1.024	0.46	0.46
WSL14	1.708	1.606	1.248	1.146	0.46	0.46
WSL2	0.976	0.853	0.726	0.603	0.25	0.25
WSL3	1.186	1.063	0.726	0.603	0.46	0.46
WSL4	1.186	1.046	0.862	0.722	0.324	0.324
WSL5	1.237	1.097	0.862	0.722	0.375	0.375
WSL6	1.322	1.182	0.862	0.722	0.46	0.46
WSL7	1.251	1.17	0.927	0.846	0.324	0.324
WSL8	1.302	1.221	0.927	0.846	0.375	0.375
WSL9	1.387	1.306	0.927	0.846	0.46	0.46

Blue highlighted items are industry standard and most frequently ordered.

WEJTAP™ INSTALLATION TOOLS

Patented



Type WTB

WEJTAP™ tool body one-piece assembly basic drive mechanism used to install WEJTAP™ connectors and STIRRUPS range - #8 awg through 1590 kcmil ACSR.

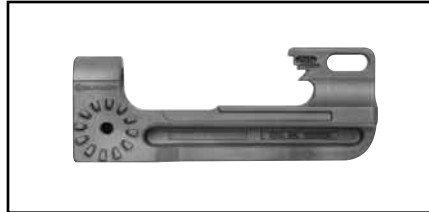

Type WTHRB1S

WEJTAP™ tool head operating platform for small and medium range (red/blue coded) connectors.

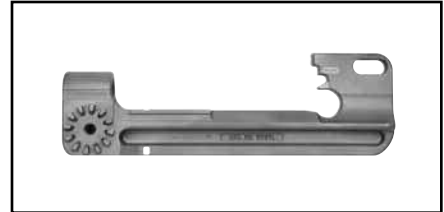

Type WTHY1S

WEJTAP™ tool head operating platform for medium and large range (yellow coded) connectors.

J-10

WEJTAP™ INSTALLATION TOOL ACCESSORIES



Type WTOCBR

WEJTAP™ removal clip for red type II and medium (blue coded) tap connectors used with type WTHRB tool head.



Type WTOCY

WEJTAP™ removal clip for large (yellow coded) tap connectors used with type WTHY tool head.

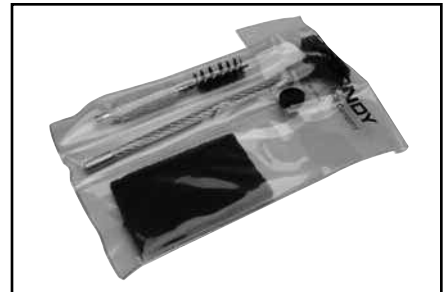

Type WTCK

WEJTAP™ tool cleaning/maintenance kit for use with type WTB tool body.

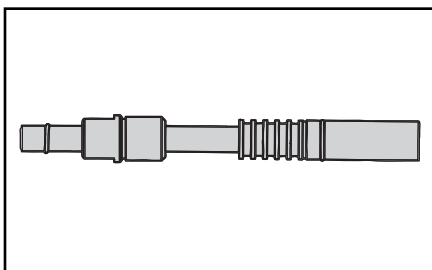

Type WTBASY1

WEJTAP™ ram replacement assembly.

Blue highlighted items are industry standard and most frequently ordered.

**WEJTAP™
POWERLUG™**

WEJTAP™ POWERLUG™ terminals are made of cast aluminum alloy for termination of ACSR and Aluminum conductors.

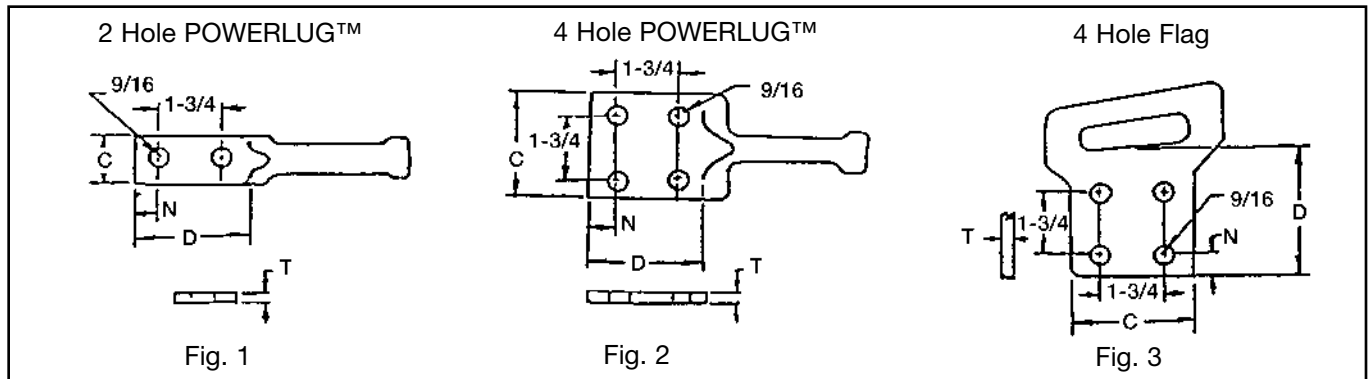

Tap Groove for Connector Selection	Catalog Number	Standard Conductor		Figure No.	Holes in Pad	Dimensions			
		ACSR	ASC/AAC			C	D	N	T
4/0 Standard ACSR	WCAB30R-2N	6 Str. - 266.8	6 Str. - 300	1	2	1-1/4	3	5/8	0.34
	WCAB30R-4N			2	4	3	3	5/8	0.30
	WCBB30R-4N			3	4	3	3	5/8	0.30
336.4 Standard ACSR	WCAY39R-2N	266.8 - 556.5	336.4 - 636	1	2	1-3/4	3	5/8	0.34
	WCAY39R-4N			2	4	3	3	5/8	0.30
	WCBY39R-4N			3	4	3	3	5/8	0.30
795 Standard ACSR	WCAY49R-2N	605 - 1033.5	715.5 - 1113	1	2	1-3/4	3-1/2	7/8	0.69
	WCAY49R-4N			2	4	3-1/2	3-1/2	7/8	0.69
	WCBY49R-4N			3	4	3-1/2	3-1/2	7/8	0.69

NOTE: The recommended connector and booster are ordered separately. Catalog number is for the POWERLUG™ only.

MULTIPLE CONDUCTOR TAP APPLICATION

Connector	*Run Groove	*Tap Groove
WCY 64 PB	Three - 1/0 ACSR (6/1) Diameter = 0.398"	One - 4/0 ACSR (6/1) Diameter = 0.563"
WCY 65 PB	Three - 1/0 ACSR (6/1) Diameter = 0.398"	One - 3/0 ACSR (6/1) Diameter = 0.502"
WCY 63 PB	Three - 2/0 ACSR (6/1) Diameter = 0.447"	One - 4/0 ACSR (6/1) Diameter = 0.563"
WCB 11 PB	Three - #4 stranded Diameter = 0.232"	One - 1/0 ACSR (6/1) Diameter = 0.398"
WCY 54 PB	Three - 1/0 stranded Diameter = 0.368"	One - 4/0 stranded Diameter = 0.522"
WCY 53 PB	Three - 1/0 stranded Diameter = 0.368"	One - 3/0 stranded Diameter = 0.464"
WCY 64 PB	Three - 2/0 stranded Diameter = 0.414"	One - 4/0 stranded Diameter = 0.522"
WCB 11 PB	Three - #4 stranded Diameter = 0.232"	One - 1/0 stranded Diameter = 0.368"

* Electrically, the three smaller conductors are the likely taps, however, during installation, they are located in the larger run groove due to their larger aggregate sum.

Blue highlighted items are industry standard and most frequently ordered.

WEJTAP™ HOTSTICK ACCESSORIES

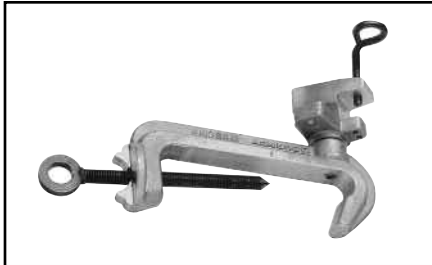

Type WHSCWH

WEJTAP™ hotstick connector clamp used to hold the tap connector spring-body and wedge for installation on energized lines with the shotgun hotstick.



Type WHSWHADP

WEJTAP™ hotstick angle wedge holder adapter attaches wedge clamp to universal hotstick for hotline installation.

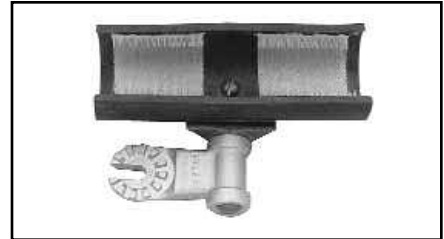

Type WHSWB

WEJTAP™ hotstick wirebrush attaches to the universal hotstick for cleaning the contact surface of the line conductor.

J-12



Type WHSPBC

WEJTAP™ hotstick dual cable clamp used to hold run and tap conductors in position during hotline installation. Universal for all applications from #8-1272 ACSR.



Type WCHAWAS

WEJTAP™ hotstick angle wedge holder adapter attaches wedge clamp to universal hotstick for hotline installation with shotgun stick.



Type WHSGB

WEJTAP™ hotstick breech drive. Geared shotgun hotstick adapter easily latches to the breech end of WEJTAP installation tool without disassembly for use on energized lines.



Type WHSSADP

WEJTAP™ hotstick spring loaded 90 degree adapter, used to attach tool to universal hotstick for hotline installations.



Type WHSTA

WEJTAP™ hotstick tool (actuator) hammer attaches to the universal hotstick for striking the tool actuator button to complete the installation.

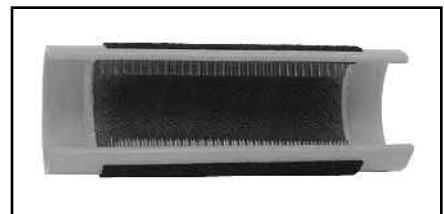

Type WHHWB

WEJTAP™ hand-held wire brush for cleaning surface contact areas on non-energized conductors.

Blue highlighted items are industry standard and most frequently ordered.

**WEJTAP™ KIT
ORDERING
INSTRUCTIONS**



Type WTCC
(Carrying Case Only)

WEJTAP™ plastic carrying case. Designed for rugged use in all weather conditions. It accommodates WEJTAP™ installation tool, removal clips, and cleaning kit.

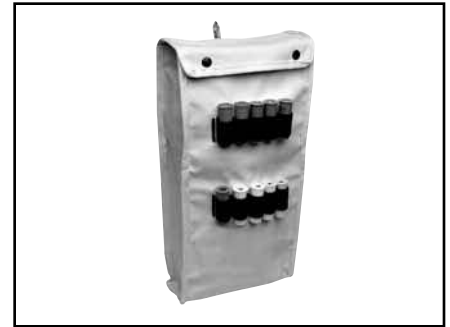

Type WABAG

WEJTAP™ accessories bag is designed for use in carrying installation tool(s), removal clips, and cleaning kit. Hotstick accessories may be accommodated as well. Holders for power boosters are conveniently located on the outside of the bag.

Tools Included in Kit (Quantity)

	*Non-Hot Stick Power Unit	Hot Stick Power Unit	Self-Firing Tool	Large Frame (Yellows)	Large Frame Take Off Clip	Small Frame (Red, Blue)	Cleaning Kit	Small Frame Take Off Clip	Molded Carrying Case	Canvas Style Tool Bag
Component	WTBNHS	WTB	WTBGBW	WTHY-1S	WTOCY	WTHRB-1S	WTCK	WTOCBR	WTCC	WABAG
Kit Catalog No.										
WT2B2RBYWABAG		2		1	1	1	1	1		1
WT2BRBYWABAG		2				1	1	1		1
WTRBYK		1		1	1	1	1	1	1	
WTRBYKNHS	1			1	1	1	1	1	1	
WTYK		1		1	1		1			
WTYKNHS	1			1	1		1			
WTRBK		1				1	1	1	1	
WTRBKNHS	1					1	1	1	1	
WT2BRBYK		2		1	1	1	1	1	1	
WT2B2RBYK		2		1	1	2	1	1	1	
WTY		1		1			1			
WTRB		1				1	1			
WTYWABAG		1		1	1		1			1
WTYKNHSBAG	1			1	1		1			1
WTRBWABAG		1				1	1	1		1
WTRBKNHSBAG	1					1	1	1		1
WTBGBWRBYK			1	1	1	1	1	1	1	
WTRBYWABAG		1		1	1	1	1	1		1
WTRBYKNHSGAB	1			1	1	1	1	1		1

* Non-Hotstick power units do not contain features allowing activation with Hotsticks. They are not upgradeable.

**Contact your BURNDY® representative for a WEJTAP™ demonstration
or contact the factory at 1-800-346-4175**

Blue highlighted items are industry standard and most frequently ordered.

WEJTAP™ In-Line Disconnect

BURNDY's new In-Line Disconnect utilizes proven WEJTAP™ Technology in combination with industry standard components to provide reliable performance of switch applications.

1. Utilizes WEJTAP™ connectors for securing the switch to the distribution line in tension applications.
2. Utilizes industry recognized and proven GST&D Products, LTD. blade components along with dual Advance Rubber Products, Inc., Insulators attached to a BURNDY® designed yoke plate assembly.
3. WEJTAP™ In-Line Disconnect designed for use in gloving and hot stick applications in conjunction with an industry standard load break tool.
4. Dual insulators minimize the switch movement during opening and closing of the blade.
5. Installation steps are minimized. The switch can be snapped directly on the line and secured with our conductor pivot retainer, designed into the switch frame.
6. WEJTAP™ tooling is used to secure the "C Member" to the built-in wedge feature of the frame. Providing reliable mechanical and electrical performance.
7. The blade is positioned on the switch to simplify cutting the conductor during installation.
8. In-Line Disconnect is removable and reusable.
9. Other conductor sizes available. Please contact factory.

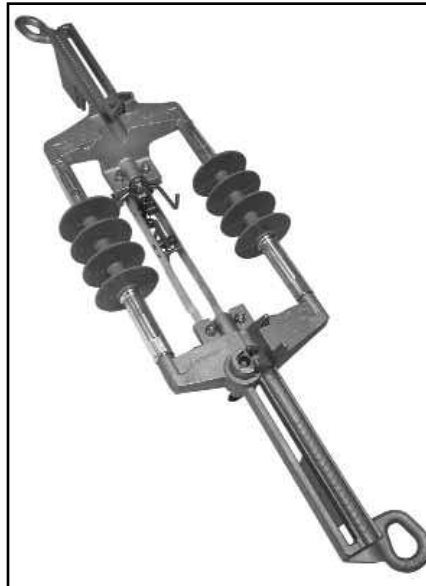

Product Specifications

- Voltage:** 15 kV (110 kV BIL),
29 kV (150 kV BIL),
35 kV (200 kV BIL)
- Current:** 900 Ampere RMS
- Short Circuit:** Momentary Current
40,000 Ampere RMS, Asymmetrical
Three Second Current
25,000 Ampere RMS, Symmetrical
- Strength:** Body 10,000 lbs.
Pulling Eye 6,000 lbs.
- Insulators:** Silicone
- Meets Industry Standards:** ANSI C119.4, C37.32
IEEE C37.30, C37.34
CSA C83.71
ASTM B117 Salt Fog

J-14

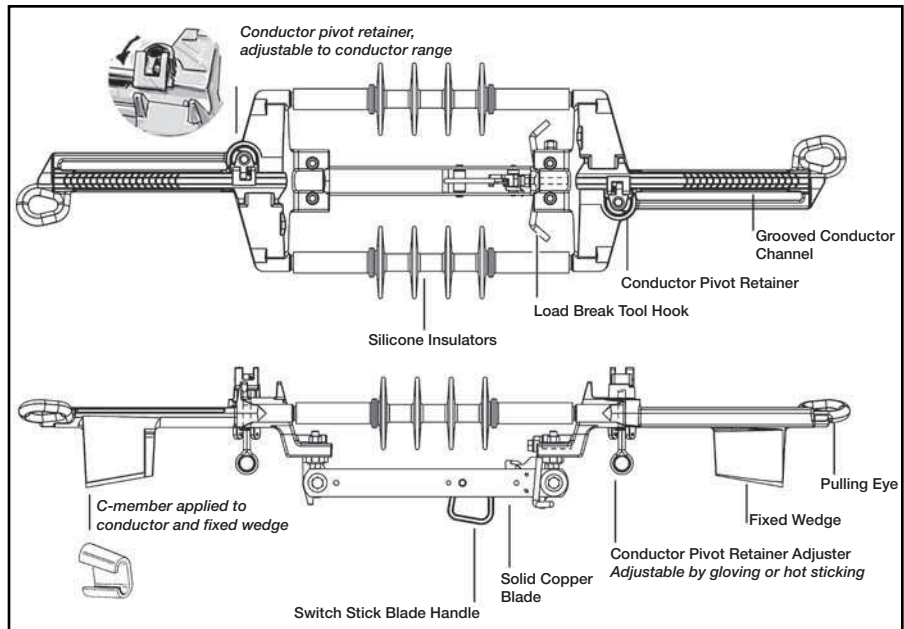

Conductor		In-Line Disconnect			Replacement Tap
ACSR	AAC	15 kV (110 kV BIL)	29 kV (150 kV BIL)	35kV (200 kV BIL)	
266.8 26/7	397.5	WAD336-15	WAD336-29	WAD336-35	WAD336S
266.8 30/7	336.4				
336.4 18/1					
336.4 26/7	350				
336.4 30/7					
397.5 18/1	450	WAD477-15	WAD477-29	WAD477-35	WAD477S
397.5 26/7	477				
397.5 30/7	500				
477 18/1					
477 26/7	556.5	WAD556-15	WAD556-29	WAD556-35	WAD556S
556.5 18/1	795				

Blue highlighted items are industry standard and most frequently ordered.